

PolarHV™ Power MOSFET

N-Channel Enhancement Mode
Avalanche Rated

IXTH 30N50P
IXTQ 30N50P
IXTT 30N50P
IXTV 30N50P
IXTV 30N50PS

$V_{DSS} = 500 \text{ V}$
 $I_{D25} = 30 \text{ A}$
 $R_{DS(on)} \leq 200 \text{ m}\Omega$

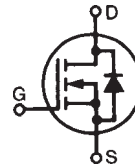

Symbol	Test Conditions	Maximum Ratings	
V_{DSS}	$T_J = 25^\circ\text{C}$ to 150°C	500	V
V_{DGR}	$T_J = 25^\circ\text{C}$ to 150°C ; $R_{GS} = 1 \text{ M}\Omega$	500	V
V_{GSS}	Continuous	± 30	V
V_{GSM}	Transient	± 40	V
I_{D25}	$T_C = 25^\circ\text{C}$	30	A
I_{DM}	$T_C = 25^\circ\text{C}$, pulse width limited by T_{JM}	75	A
I_{AR}	$T_C = 25^\circ\text{C}$	30	A
E_{AR}	$T_C = 25^\circ\text{C}$	40	mJ
E_{AS}	$T_C = 25^\circ\text{C}$	1.2	J
dv/dt	$I_S \leq I_{DM}$, $di/dt \leq 100 \text{ A}/\mu\text{s}$, $V_{DD} \leq V_{DSS}$, $T_J \leq 150^\circ\text{C}$, $R_G = 5 \Omega$	10	V/ns
P_D	$T_C = 25^\circ\text{C}$	460	W
T_J		-55 ... +150	$^\circ\text{C}$
T_{JM}		150	$^\circ\text{C}$
T_{stg}		-55 ... +150	$^\circ\text{C}$
T_L	1.6 mm (0.062 in.) from case for 10 s	300	$^\circ\text{C}$
T_{SOLD}	Plastic body for 10 s	260	$^\circ\text{C}$
M_d	Mounting torque (TO-247, TO-3P)	1.13/10	Nm/lb.in.
F_c	Mounting force (PLUS220, PLUS220SMD)	11 65/2.5 15	N/lb.
Weight	PLUS220, PLUS220SMD	4	g
	TO-268	5	g
	TO-3P	5.5	g
	TO-247	6	g

TO-247 AD (IXTH)

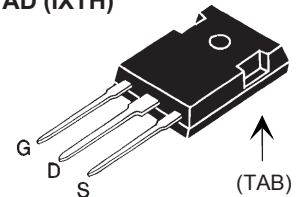

TO-3P (IXTQ)

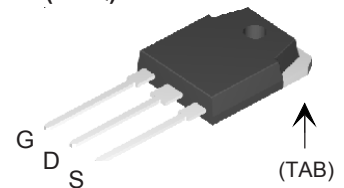

TO-268 (IXTT)

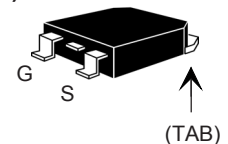

PLUS220 (IXTV)

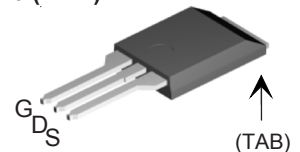

PLUS220 SMD (IXTV..S)

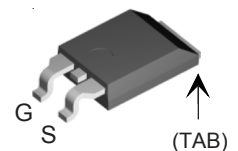

G = Gate D = Drain
S = Source TAB = Drain

Symbol	Test Conditions ($T_J = 25^\circ\text{C}$, unless otherwise specified)	Characteristic Values		
		Min.	Typ.	Max.
BV_{DSS}	$V_{GS} = 0 \text{ V}$, $I_D = 250 \mu\text{A}$		500	V
$V_{GS(th)}$	$V_{DS} = V_{GS}$, $I_D = 250 \mu\text{A}$		3.0	5.0 V
I_{GSS}	$V_{GS} = \pm 30 \text{ V}$, $V_{DS} = 0 \text{ V}$			$\pm 100 \text{ nA}$
I_{DSS}	$V_{DS} = V_{DSS}$, $V_{GS} = 0 \text{ V}$			25 μA 250 μA
$R_{DS(on)}$	$V_{GS} = 10 \text{ V}$, $I_D = 0.5 I_{D25}$ Pulse test, $t \leq 300 \mu\text{s}$, duty cycle $d \leq 2\%$	165	200	$\text{m}\Omega$

Features

- International standard packages
- Unclamped Inductive Switching (UIS) rated
- Low package inductance
- easy to drive and to protect

Advantages

- Easy to mount
- Space savings
- High power density

Symbol	Test Conditions	Characteristic Values ($T_J = 25^\circ\text{C}$, unless otherwise specified)		
		Min.	Typ.	Max.
g_{fs}	$V_{DS} = 20\text{ V}$; $I_D = 0.5 I_{D25}$, pulse test	17	27	S
C_{iss}	$V_{GS} = 0\text{ V}$, $V_{DS} = 25\text{ V}$, $f = 1\text{ MHz}$		4150	pF
C_{oss}			445	pF
C_{rss}			28	pF
$t_{d(on)}$	$V_{GS} = 10\text{ V}$, $V_{DS} = 0.5 V_{DSS}$, $I_D = 0.5 I_{D25}$ $R_G = 5\ \Omega$ (External)		25	ns
t_r			27	ns
$t_{d(off)}$			75	ns
t_f			21	ns
$Q_{g(on)}$	$V_{GS} = 10\text{ V}$, $V_{DS} = 0.5 V_{DSS}$, $I_D = 0.5 I_{D25}$		70	nC
Q_{gs}			27	nC
Q_{gd}			22	nC
R_{thJC}	(TO-247, TO-3P and PLUS220)		0.21	0.27°C/W
R_{thCS}				$^\circ\text{C/W}$

Source-Drain Diode		Characteristic Values ($T_J = 25^\circ\text{C}$, unless otherwise specified)		
Symbol	Test Conditions	Min.	Typ.	Max.
I_S	$V_{GS} = 0\text{ V}$			30 A
I_{SM}	Repetitive			90 A
V_{SD}	$I_F = I_S$, $V_{GS} = 0\text{ V}$, Pulse test, $t \leq 300\ \mu\text{s}$, duty cycle $d \leq 2\%$			1.5 V
t_{rr}	$I_F = 18\text{ A}$, $-di/dt = 100\text{ A}/\mu\text{s}$		400	ns

Fig. 1. Output Characteristics
@ 25°C

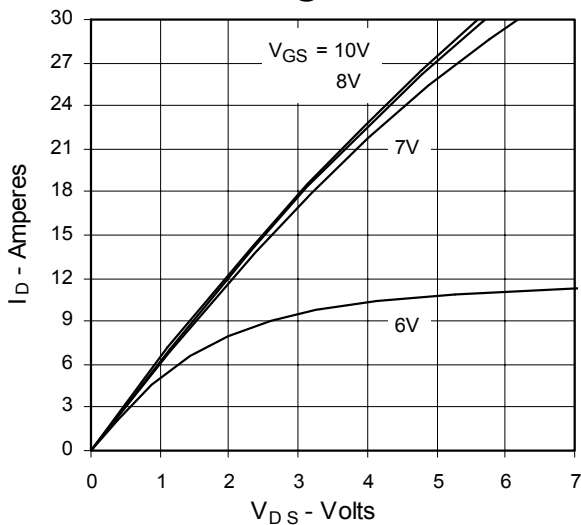
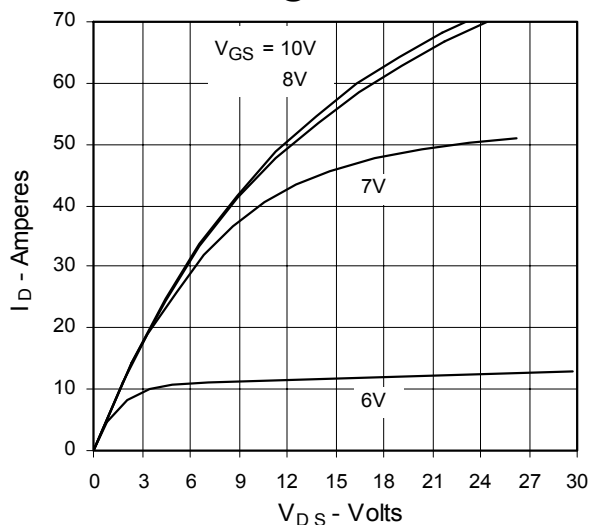

Fig. 2. Extended Output Characteristics
@ 25°C



IXYS reserves the right to change limits, test conditions, and dimensions.

IXYS MOSFETs and IGBTs are covered by 4,835,592 4,931,844 5,049,961 5,237,481 6,162,665 6,404,065 B1 6,683,344 6,727,585
one or more of the following U.S. patents: 4,850,072 5,017,508 5,063,307 5,381,025 6,259,123 B1 6,534,343 6,710,405 B2 6,759,692
4,881,106 5,034,796 5,187,117 5,486,715 6,306,728 B1 6,583,505 6,710,463 6,771,478 B2

Fig. 3. Output Characteristics @ 125°C

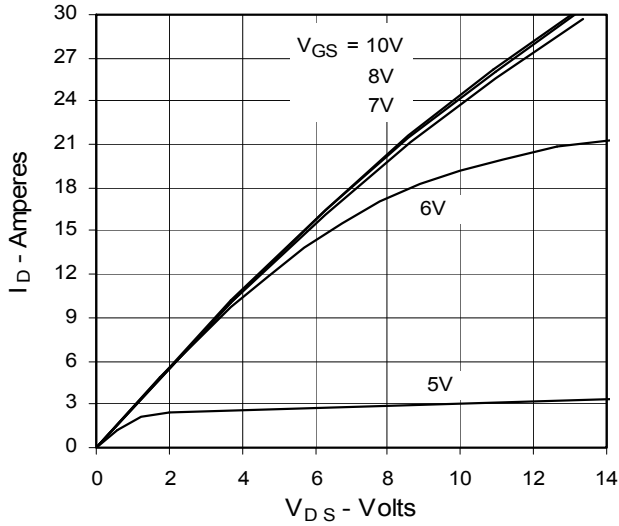

Fig. 4. $R_{DS(on)}$ Normalized to 0.5 I_{D25} Value vs. Junction Temperature

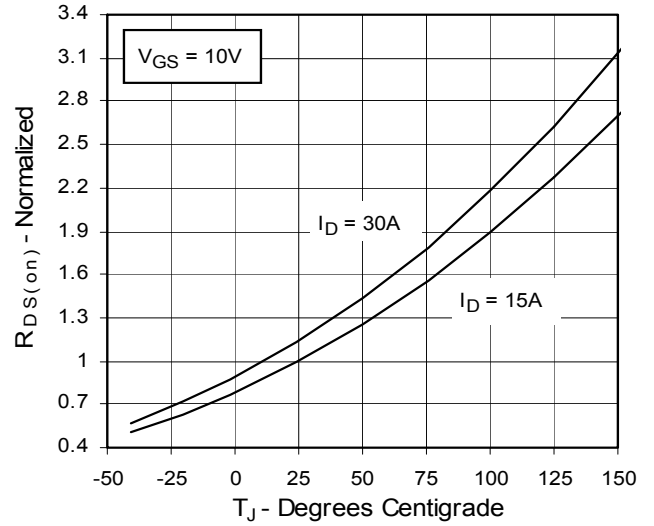

Fig. 5. $R_{DS(on)}$ Normalized to 0.5 I_{D25} Value vs. I_D

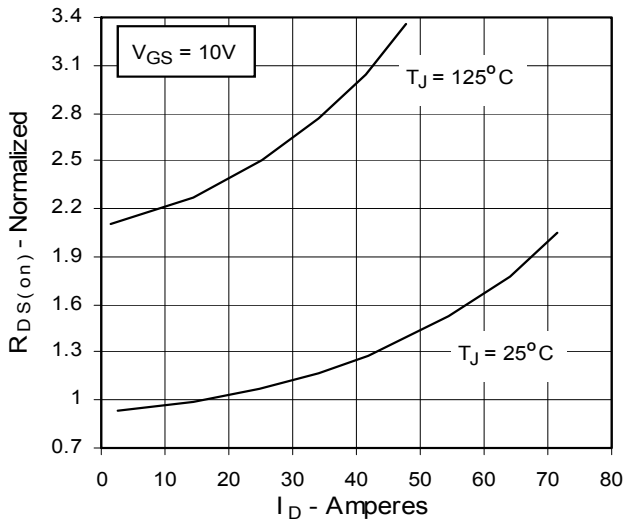

Fig. 6. Drain Current vs. Case Temperature

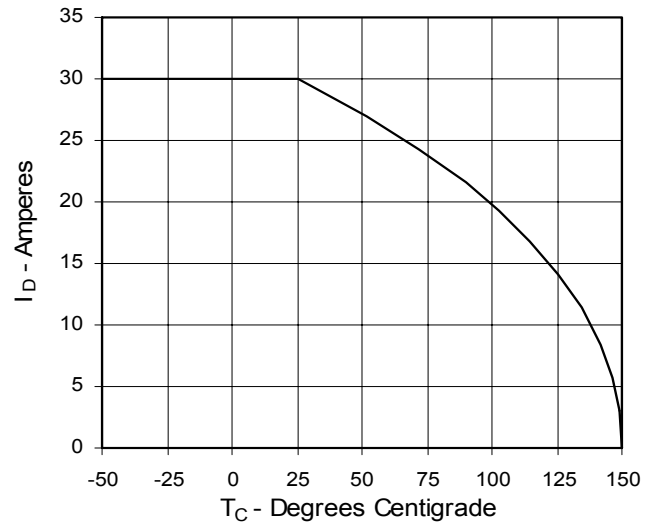

Fig. 7. Input Admittance

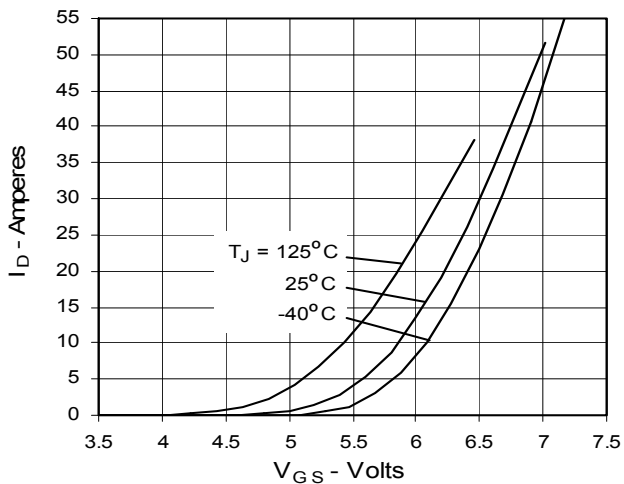

Fig. 8. Transconductance

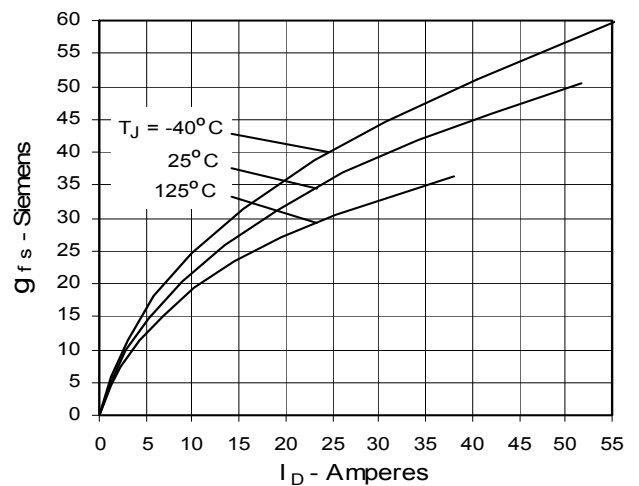

Fig. 9. Source Current vs. Source-To-Drain Voltage

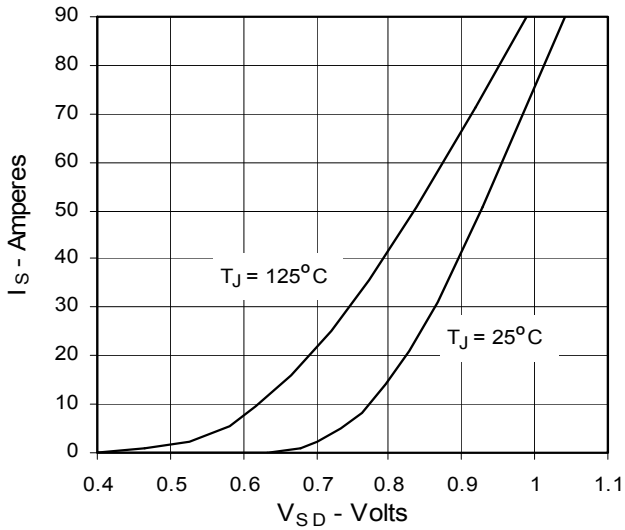

Fig. 10. Gate Charge

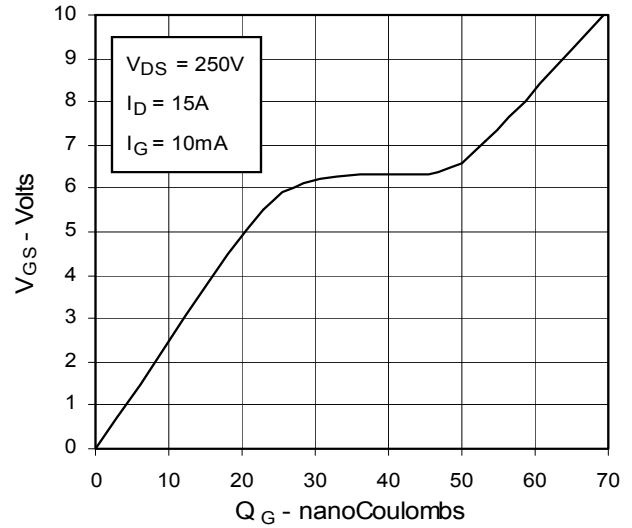

Fig. 11. Capacitance

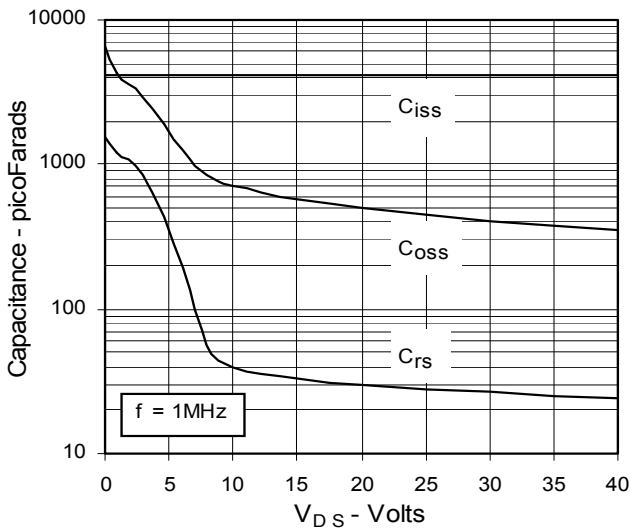

Fig. 12. Forward-Bias Safe Operating Area

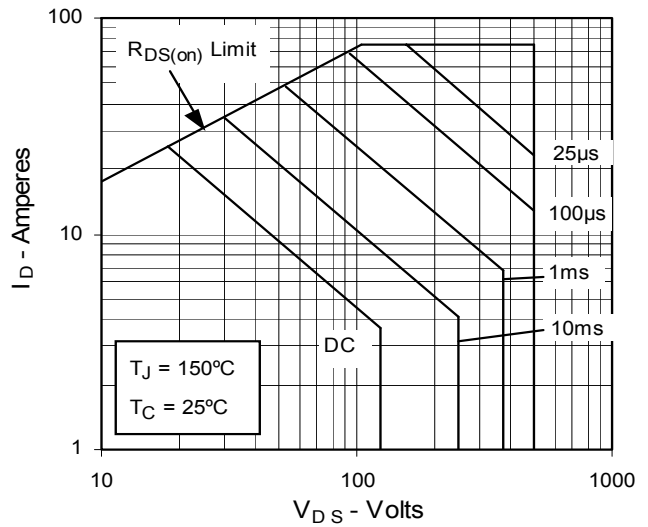
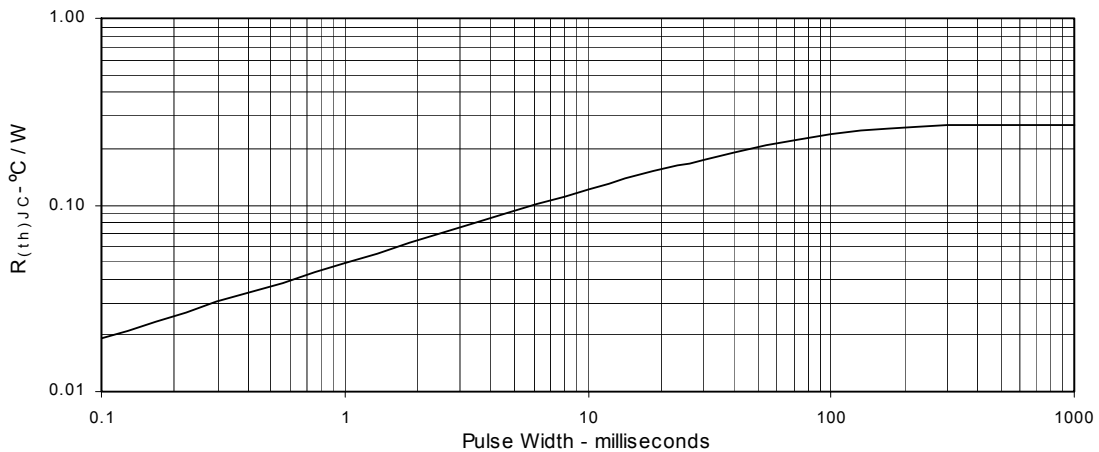
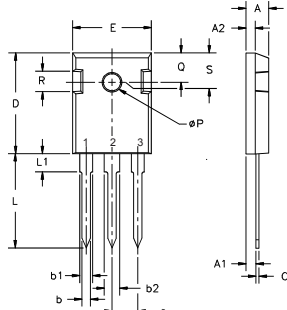

Fig. 13. Maximum Transient Thermal Resistance



Package Outline Drawings

TO-247 (IXTH) Outline



Terminals: 1 - Gate
2 - Drain
3 - Source
Tab - Drain

Dim.	Millimeter		Inches	
	Min.	Max.	Min.	Max.
A	4.7	5.3	.185	.209
A ₁	2.2	2.54	.087	.102
A ₂	2.2	2.6	.059	.098
b	1.0	1.4	.040	.055
b ₁	1.65	2.13	.065	.084
b ₂	2.87	3.12	.113	.123
C	.4	.8	.016	.031
D	20.80	21.46	.819	.845
E	15.75	16.26	.610	.640
e	5.20	5.72	0.205	0.225
L	19.81	20.32	.780	.800
L ₁		4.50		.177
∅P	3.55	3.65	.140	.144
Q	5.89	6.40	0.232	0.252
R	4.32	5.49	.170	.216
S	6.15 BSC		242 BSC	

TO-3P (IXTQ) Outline

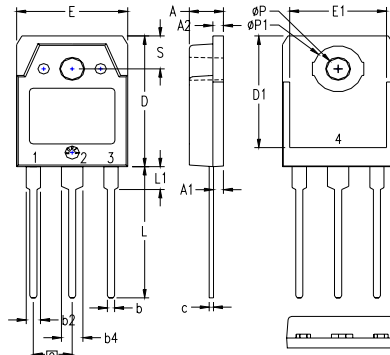

1 - GATE
2 - DRAIN (COLLECTOR)
3 - SOURCE (EMITTER)
4 - DRAIN (COLLECTOR)

SYM	INCHES		MILLIMETERS	
	MIN	MAX	MIN	MAX
A	.185	.193	4.70	4.90
A ₁	.051	.059	1.30	1.50
A ₂	.057	.065	1.45	1.65
b	.035	.045	0.90	1.15
b ₂	.075	.087	1.90	2.20
b ₄	.114	.126	2.90	3.20
c	.022	.031	0.55	0.80
D	.780	.799	19.80	20.30
D ₁	.665	.677	16.90	17.20
E	.610	.622	15.50	15.80
E ₁	.531	.539	13.50	13.70
e	.215 BSC		5.45 BSC	
L	.779	.795	19.80	20.20
L ₁	.134	.142	3.40	3.60
∅P	.126	.134	3.20	3.40
∅P ₁	.272	.280	6.90	7.10
S	.193	.201	4.90	5.10

TO-268 (IXTT) Outline

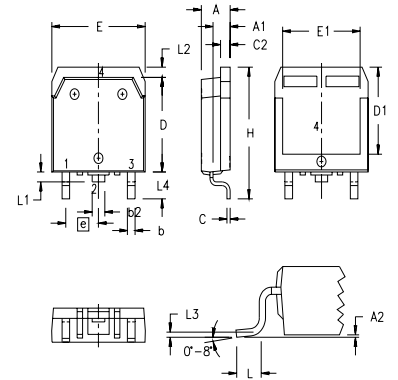

SYM	INCHES		MILLIMETERS	
	MIN	MAX	MIN	MAX
A	.193	.201	4.90	5.10
A ₁	.106	.114	2.70	2.90
A ₂	.001	.010	0.02	0.25
b	.045	.057	1.15	1.45
b ₂	.075	.083	1.90	2.10
C	.016	.026	0.40	0.65
C ₂	.057	.063	1.45	1.60
D	.543	.551	13.80	14.00
D ₁	.488	.500	12.40	12.70
E	.624	.632	15.85	16.05
E ₁	.524	.535	13.30	13.60
e	.215 BSC		5.45 BSC	
H	.736	.752	18.70	19.10
L	.094	.106	2.40	2.70
L ₁	.047	.055	1.20	1.40
L ₂	.039	.045	1.00	1.15
L ₃	.010 BSC		0.25 BSC	
L ₄	.150	.161	3.80	4.10

PLUS220 (IXTV) Outline

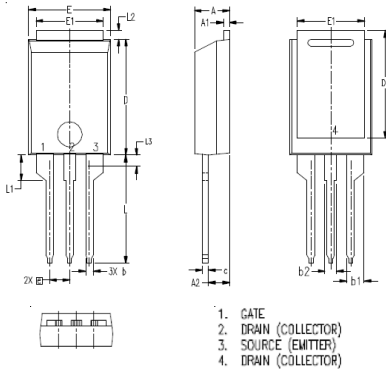

1. GATE (COLLECTOR)
2. DRAIN (COLLECTOR)
3. SOURCE (EMITTER)
4. DRAIN (COLLECTOR)

SYM	INCHES		MILLIMETER	
	MIN	MAX	MIN	MAX
A	.169	.185	4.30	4.70
A ₁	.028	.035	0.70	0.90
A ₂	.098	.118	2.50	3.00
b	.035	.047	0.90	1.20
b ₁	.080	.095	2.03	2.41
b ₂	.054	.064	1.37	1.63
c	.028	.035	0.70	0.90
D	.551	.591	14.00	15.00
D ₁	.512	.539	13.00	13.70
E	.394	.433	10.00	11.00
E ₁	.331	.346	8.40	8.80
e	.100 BSC		2.54 BSC	
L	.512	.551	13.00	14.00
L ₁	.118	.138	3.00	3.50
L ₂	.035	.051	0.90	1.30
L ₃	.047	.059	1.20	1.50

PLUS220SMD (IXTV_S) Outline

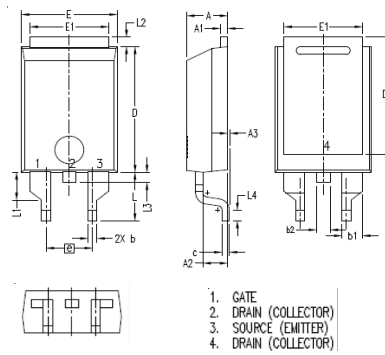

1. GATE (COLLECTOR)
2. DRAIN (COLLECTOR)
3. SOURCE (EMITTER)
4. DRAIN (COLLECTOR)

SYM	INCHES		MILLIMETER	
	MIN	MAX	MIN	MAX
A	.169	.185	4.30	4.70
A ₁	.028	.035	0.70	0.90
A ₂	.098	.118	2.50	3.00
A ₃	.000	.010	0.00	0.25
b	.035	.047	0.90	1.20
b ₁	.080	.095	2.03	2.41
b ₂	.054	.064	1.37	1.63
c	.028	.035	0.70	0.90
D	.551	.591	14.00	15.00
D ₁	.512	.539	13.00	13.70
E	.394	.433	10.00	11.00
E ₁	.331	.346	8.40	8.80
e	.200 BSC		5.08 BSC	
L	.209	.228	5.30	5.80
L ₁	.118	.138	3.00	3.50
L ₂	.035	.051	0.90	1.30
L ₃	.047	.059	1.20	1.50
L ₄	.039	.059	1.00	1.50